

# B6 10 PRO

All specifications and figures are subject to change without notice. Printed in China ©2010



# B6 10 PRO

## Professional Balance Charger

Microprocessor controlled high-performance rapid charger/discharger with integrated balancer USB PC link and temperature sensor

Charge current up to 10A, discharge current up to 5A, 1 to 6 series of LiLo/LiFe, 1 to 18 cells of NiCd/NiMH, 2 to 24V of Lead-acid(Pb)



# Instruction Manual

[www.imaxrc.com](http://www.imaxrc.com)

## Introduction

Thank you for purchasing the B6 10 Pro Charger by ImaxRC. You get a rapid charger/discharger with integrated balancing circuit, which is computerised with a high performance microprocessor and specialised operating software. It can maintain your battery at its best condition and also control them safely please read this operating manual completely and attentively as it contains a wide variety of specific programming and safety information.

You need to keep this manual in a safe place, and be sure to pass it on to the new owner if you ever dispose of B6 10 Pro.

## Special features

### - Operating software

Every operating program in the unit is controlled with mutual links and communications to prevent every possible error, so it introduces the maximum safety, such as input voltage warning, reverse polarity protection and Lithium cell-count input error warning.

### - High-power and high-performance circuit

B6 10 Pro employs the circuit that has maximum output power of 200Watts. As a result, it can charge or discharge up to 18 cells of NiCd/NiMH and 6 series of Lithium batteries with maximum current of 10A. Furthermore, the cooling system is so efficient that can hold such a power without any trouble of running the circuit or the operating program.

### - Individual voltage balancer for Lithium batteries

B6 10 Pro has an individual cell voltage balancer inside. So it does not need any balancer separately when charging Lithium batteries (Lilo/LiPo/LiFe) for voltage balancing.

### - Balance individual cells on discharge

B6 10 Pro also can monitor and balance individual cells of the Lithium battery pack during the discharge process. If the voltage of any one cell varies abnormally, the process will be stopped with the error message.

### - Accept various types of Lithium battery

B6 10 Pro can accept three types of Lithium batteries - Lilo, Lipo and LiFe. They have different characteristics by their chemistry. You can select any one of them that you are going to process before the job. For their specifications, refer 'Warnings and safety notes' section.

### - Lithium battery 'Fast' and 'Storage' mode

You can charge Lithium battery for special purposes. 'Fast' charge reduces the charging time of Lithium battery and 'storage' mode controls the final voltage of the battery to be suit for long time storage.

### - Maximum safety

Delta-peak sensitivity: The automatic charge termination program works on the principle of the Delta-peak voltage detection. (NiCd/NiMH)

Auto-charge current limit: When charging NiCd or NiMH at 'AUTO' current mode, you can set the upper limit of charge current to avoid from feeding high current to the

battery. This is very useful when charging the low impedance and small capacity NiMH battery in 'AUTO' mode.

Capacity limit: The charging capacity always calculated by multiple of the charging current and time. If the charging capacity exceeds the limit the process will be terminated automatically when you set the maximum value.

Temperature limit(\*): The temperature of the battery on charging will rise by its internal chemical reaction. If you set the limit of temperature the process will be expired forcibly when the limit has been reached.

Processing time limit: You can also restrain the maximum processing time to prevent from any possible defect.

Input power monitor: To protect the car battery using as input power from being damaged, its voltage always being monitored. If it drops below the lower limit the process will be ended automatically.

Automatic cooling fan: The electric cooling fan comes into action automatically only when the internal temperature of the unit is raised.

### - Data store/load

For users convenience, it can store maximum 10 data of different batteries. You can establish the data contains program setting of the battery to charge or discharge. These data can be called back at any time you need and the process can be executed without program setting.

### - Cyclic charging/discharge

Perform 1 to 5 cycles of charge>discharge or discharge>charge continually for battery refreshing and balancing.

### - PC based analysis using USB communication(\*\*)

For technical expert, B6 10 Pro offers PC based program can analysis the characteristic of the battery by USB port. It shows a graph of voltage, current, capacity and temperature curves. It also shows the individual voltage of each cell in the Lithium battery pack.

\*When using the thermal probe (Part no. EAC110)

\*\*Separately purchased program kit (EAC200, CD plus USB link cable)

## Exterior of the unit



## Warnings and safety notes

- Never leave the charge unsupervised when it is connected to its power supply. If any malfunction is observed immediately terminate the process and refer to the operation manual.
- Keep away the unit from dust, damp, rain, heat direct sunshine and vibration. Do not drop it.
- The circuit of the unit is designed to be powered by a 12V DC only.
- This unit and the battery to charge or discharge should be set up on a head-resistant, non-inflammable and non-conductive surface. Never place them on a car seat, carpet or similar. Keep all the inflammable volatile materials well away from operating area.

Be sure to understand the information of the battery to be charged or discharged accurately. If the program is set up incorrectly the battery can severely be damaged. Especially Lithium battery can cause a fire or an explosion by over-charging.

NiCd/NiMH voltage level: 1.2V/cell  
allowable fast charge current: 1C–2C depends on the performance of cell  
discharge voltage cut off level: 0.85V/cell (NiCd), 1.0V/cell (NiMH)

Lilo voltage level: 3.6V/cell  
max. charge voltage: 4.1V/cell  
allowable fast charge current: 1C or less  
min. discharge voltage cut off level: 2.5V/cell or higher

LiPo voltage level: 3.7V/cell  
max. charge voltage: 4.2V/cell  
allowable fast charge current: 1C or less  
discharge voltage cut off level: 3.0V/cell or higher

LiFe voltage level: 3.3V/cell  
max. charge voltage: 3.6V/cell  
allowable fast charge current: 4C or less (e.g. A123M1)  
discharge voltage cut off level: 2.0V/cell or higher

Pb (Lead-acid) voltage level: 2.0V/cell  
max. charge voltage: 2.46V/cell  
allowable fast charge current: 0.4C or less  
discharge voltage cut off level: 1.75V/cell or higher

- To avoid short-circuits between the charge lead, always connect the charge cable to the unit first and only then to the battery to be charged or discharged. Reverse the sequence when disconnecting.
- Do not connect more than one battery pack to the charge lead at any one time.

- Do not attempt to charge or discharge the following types of battery.
  - Battery pack, which consists of different types of cell (including different manufacturers).
  - Battery, which is already fully charged or just slightly discharged.
  - Non-rechargeable batteries (Explosion hazard).
  - Batteries that require a different charge technique from NiCd, NiMH, Lilo, LiPo, LiFe or Pb
  - Faulty or damaged battery.
  - Battery fitted with an integral charge circuit or a protection circuit.
  - Batteries installed in a device, or which are electrically linked to other components.
  - Batteries that are not expressly stated by the manufacturer to be suitable for the currents the charger delivers during the charge process.
- Please bear in mind of checking the following point before charge operation.
  - Did you select the appropriate program, which are suitable for the type of battery?
  - Did you set up adequate current for charging or discharging?
  - Lithium battery pack can be composed with parallel and series circuits mixed. You have to check the composition of the battery pack carefully before charging.
  - Are all connections firm and safe, or is there an intermittent contact at any point in the circuit?

### ● Charging

A specific quantity of electrical energy is fed into the battery during charge process. The charge quantity is calculated by multiplying charge time. The maximum permissible charge current varies according to the battery type or its performance, and can be found in the information provided by the battery manufacturer. It is only allowed to charge batteries at rates higher than the standard charge current if they are expressly stated to be capable of quick-charge.

- Connect the battery to charge to output terminal of the charge using suitable charge lead. They are red, positive (+) and black, negative (-). Since the charge cannot detect the difference between the internal resistance of the battery pack, cable resistance and connector transfer resistance, the first requirement if the charger to work properly is that the charge lead should be of adequate conductor cross-section. And also high-quality connectors (normally gold-contact type) must be fitted to both ends.

- Refer to the information provided by the battery manufacturer regarding charging methods, and verify the recommended charge current and charge time. Especially for lithium batteries, you have to follow the charge instruction provided by the manufacturer strictly.

- Do not attempt to disassemble the battery pack arbitrarily.

- You have to pay attention to verify the capacity and the voltage of the Lithium battery pack. It may be composed of parallel and series connection mixed. In parallel link the capacity of the battery pack is multiplied by the number of cells but the voltage remains same. That kind of voltage imbalance causes a fire or explosion during charge process. We recommend you compose the Lithium battery pack in series only.

### ● Discharge

The typical purpose of discharge is to determine the residual capacity of the battery, or to lower the voltage of battery to a defined level. When you discharge

the battery you also have to pay attention on the process same as charging. To avoid the battery becoming deep-discharged, set the final discharge voltage correctly. Lithium batteries should not be deep-discharged, set the final discharge voltage, as this leads to a rapid loss of capacity or a total failure. Generally, you do not need to discharge Lithium battery voluntarily.

-Some rechargeable batteries are said to have a memory effect. If they are partly used and recharged before the whole charge is drawn out, they 'remember' this and next time will only use that part of their capacity. This is a 'memory effect'. NiCd and NiMH batteries are said to suffer from memory effect. They prefer complete cycles; fully charge then use until empty, do not recharge before storage - allow them to self-discharge during storage. NiMH batteries have less memory effect than NiCd.

-The Lithium battery prefers a partial than a full discharge. Frequent full discharges should be avoided if possible. Instead, charge the battery more often or use a larger battery.

-The brand-new NiCd battery pack is partially useful with its capacity until it has been subjected to 10 or more charge cycles in any case. The cyclic process of charge and discharge will lead to optimise the capacity of battery pack.

**\*Those warnings and safety and safety notes are particularly important. Please follow the instructions for a maximum safety; otherwise the charger and the battery can be damaged violently. And also it can cause a fire to injure a human body or to lose the property.**

## Program flow chart

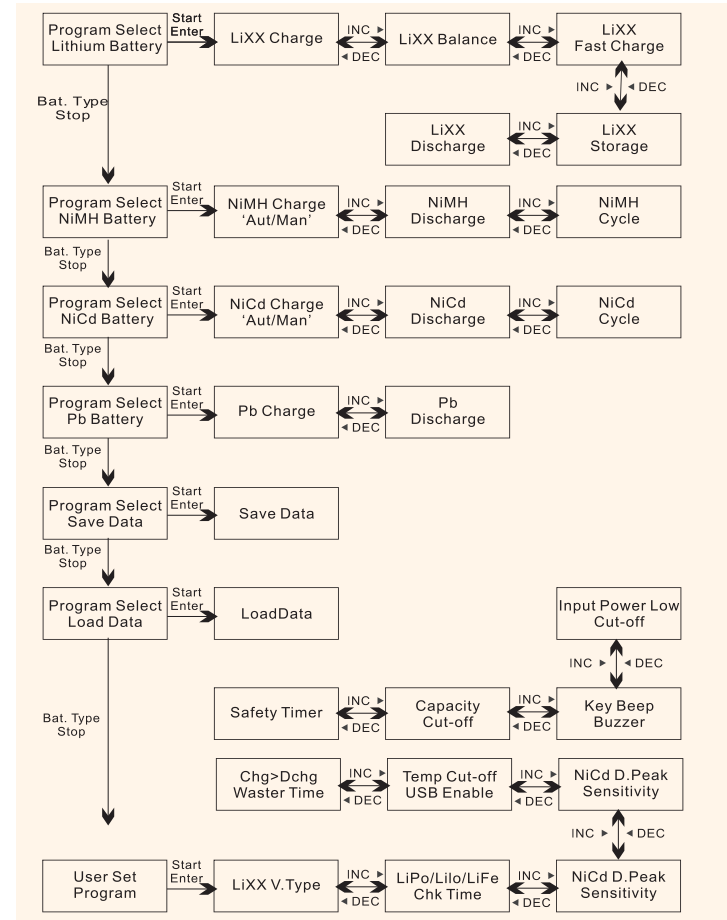

## Initial parameter set up(Users set program)

B6 10 Pro will be operated with the default value of the essential user settings when it is connected to a 12V battery for the first time. The screen displays the following information in sequence and the user can change the value of parameter on each screen. When you are willing to alter the parameter value in the program, press **Start/Enter** key to make it blink then change the value with **INC** or **DEC** key. The value will be stored by pressing Start/Enter key once.

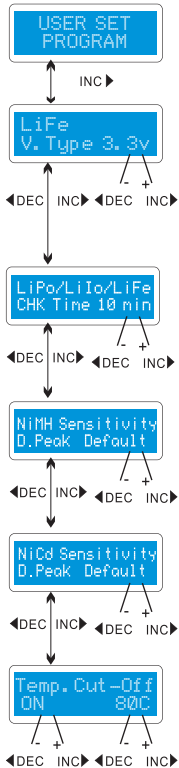

This informs you of its designation.

The screen displays the nominal voltage of Lithium battery. There are three kinds of Lithium battery; LiFe(3.3V), Lilo(3.6V) or LiPo(3.7V). This is very important so you have to check the battery carefully and set it up correctly. If it is different from correct value the battery can explode during charge process.

B6 10 Pro recognise the cell count of Lithium battery automatically at the beginning of charge or discharge process to avoid form erroneous setting by use. But deeply discharged battery can be perceived incorrectly. To prevent the error, you can set the time term to verify the cell count by the processor. Normally, 10 minutes are enough to perceive the cell count correctly. For the battery of larger capacity, you may extend the time term. But if you set the time term too long for the battery of smaller capacity, the charge or discharge process can be finished within the time term with the erroneous cell count. This may cause the fatal result. If the processor recognizes the cell count incorrectly at the beginning of charge or discharge process, you may extend the time. Otherwise, you had better use with the default value.

This shows the trigger voltage for automatic charge termination of NiMH and NiCd battery. The effective value ranges from 5 to 20mV per cell. If the trigger voltage is set higher, there is a possibility of premature termination. Please refer the technical specificl specification of the battery. (NiCd default: 12mV/cell, NiMH default: 7mV/cell)

An optional feature using temperature probe contacting the surface of battery, the temperature cut-off can be on or off, if it is on, set the maximum temperature at which the charger should allow battery to reach during charge. Once a battery reaches this temperature during operation, the process will be terminated to protect the battery.

The battery is on the cyclic process of charge and discharge can often become warm after charge or discharge period. The program can insert a time delay to occur after each charge and discharge process to allow the battery adequate time to cool down before being subjected to the next process. The value ranges from 1 to 60 minutes.

You can set the trickle charge mode on or off. If it is on, the charger will automatically supply the trickle charge current to achieve the full without overheating the battery after fast charge has been terminated.

When you start a charge process, the integral safety timer automatically starts running at the same time. This is programmed to prevent overcharge the battery if it proves to be faulty, or if the termination circuit cannot detect the battery full. The value for the safety timer should be generous enough to allow a full charge of the battery.

This program sets the maximum charge capacity that will be supplied to the battery during charge. If the delta-peak voltage is not detected nor the safety timer expired by any reason, this feature will automatically stop the process at the selected capacity value.

The beep sounds at every time pressing the buttons to confirm your action. The beep or melody sounded at various times during operation to alert different mode changes. These audible sounds can be on or off.

This program monitors the voltage of input battery. If the voltage drops below the value you set the operation forcibly terminated to protect the input battery.

You can adjust the brightness of LCD screen at the charge.

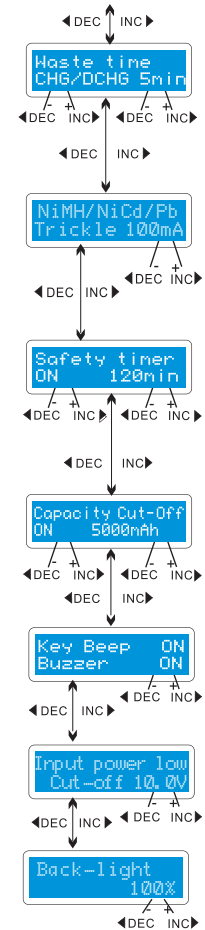

## Lithium battery(LiLo/LiPo/LiFe)program

These programs are only suitable for charging and discharging Lithium batteries with a nominal voltage of 3.3V,3.6V and3.7V per cell.These batteries need to adopt different charge technique is termed constant voltage(CV) and constant current(CC) method.The charge current varies according to the battery capacity and performance.The final voltage of charge process is also very important,it should be precisely matched with the charged voltage of the battery.They are 4.2V for Lipo,4.1v for Lilo,and 3.6V for LiFe.The charge current and nominal voltage as for cell count set on the charge program must always be correct for battery to be charged. When you are willing to alter the parameter value in the program,press Start key to make it blink then change the value with INC or DEC key.The value will be stored by pressing Start key once.

### Charging Lithium battery

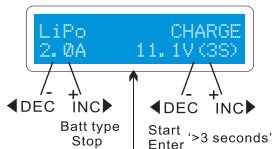

The left side of the first line shows the type of battery you select at the users setting.The value on the left side of second line sets a charge current and the value on the right side of second line sets the voltage of the battery pack. After setting the current and voltage press Start key for more than 3 seconds to start the process.(Charge current:0.1~10.0A,Voltage:1~6series)



This shows the number of cells you set up and the processor detects.'S:'is the number of cells selected by you at the previous screen.If both numbers are identical you can start charging press Start button.If not,press Batt type button to go back to previous screen.Then carefully check the number of cells of the battery pack to charge again.

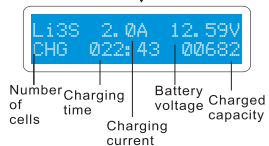

The screen shows the present situation during charge process.To stop charging press Batt type key once.

### Charging Lithium battery at balance mode

This is for balancing the voltages of Lithium batteries of the battery pack to be charged.To do this,the battery pack being charged should have the individual cell connector.And connect it to the individual port at the right side of charger with a suitable connection cable that fits with your battery pack.And also,you should to connect the battery output plug to the output of charger.

In this mode,the charging process will be different from ordinary charging mode.The internal processor of the charger will monitor the voltages of each cell of the battery pack and controls the charging current that is feeding to each cell to normalize the voltage.

The value on the left side of second line sets a charge current and the value on the right side of second line sets the voltage of the battery pack. After setting the current and voltage press Start key for more than 3 second to start the process.(Charge current:0.1~10.0A,Voltage:1~6 series)

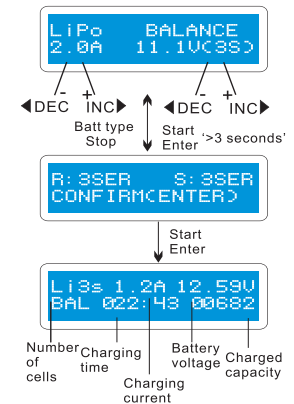

This shows the number of cells you set up and the processor detects,'R:'shows the number of cells found by you at the previous screen.If both number are identical you can start charging by press Start button.If not,press Batt type button to go back to previous screen.Then carefully check the number of cells of the battery pack to charge again.

The screen shows the present situation during charge process.To stop charging press Batt type key once.

### Individual cell connection diagram(pin-assignment of 8-pin)

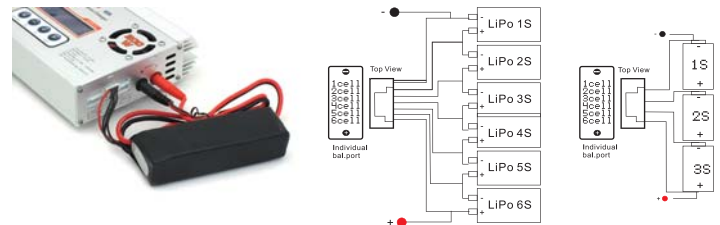

**'FAST' charging Lithium battery**

The charging current getting smaller as the process goes to the near end term of Lithium battery charging.To finish charging process earlier,this program eliminate certain term of CV process.Actually,the charging current will goes to 1/5 from the initial value to end the process while the normal charging goes to 1/10 during CV term.The charging capacity may be a bit smaller than normal charging but the process time will be reduced.

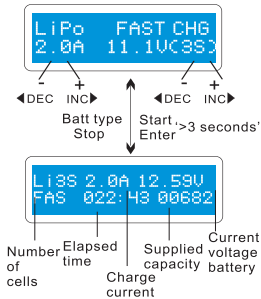

You can set up the charging current and the voltage of the battery pack being charged.As you press **Start/Enter** button the voltage confirmation will be displayed.And then,If you confirm the voltage and current,press **Start/Enter** button again to **start/Enter** button again to start charging.

This shows the present state of 'FAST' charging.To stop charging arbitrary,press **Batt type/stop** key once.

**'STORAGE' control Lithium battery**

This is for charging or discharging Lithium battery not to be used for the time being.The program will determine to charge or discharge the battery to the certain voltage depending on the voltage of the battery at its initial stage.They are different from the type of the battery,3.75V for Lilo,3.85V fro Lipo and 3.3V for LiFe per cell.If the voltage of battery at its initial stage is over the voltage level to storage,the program will start to discharge.

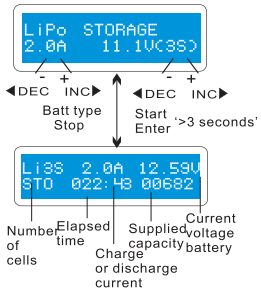

You can set up the current and the voltage of the battery pack to be charged.The current will be used for charge or discharge the battery to reach the 'storage' level of voltage.

The screen shows the present situation during charge process.To stop charging press **Batt type/Stop** key once.

**Discharging Lithium battery**

The value of discharge current on the left side of screen may not exceed 1C for a maximum safety and the final voltage on the right should not be under the voltage level that is recommended by the battery manufacturer to avoid deep discharging.

To start to discharge press Start/Enter key for more than 3 seconds.  
(Discharge current:0.1-5.0A)

This shows the present state of discharge.To stop discharging press Batt type/Stop key once.

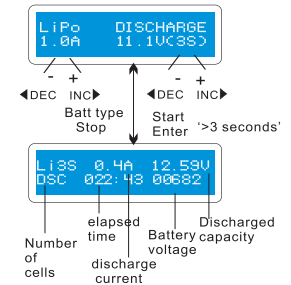
**\*Voltage balancing and monitoring during the discharge**

The processor monitors the volgae of individual cells during 'storage-mode' and 'discharge' of Lithium battery pack. It tries to normalise the voltages to be equal. For this feature,the individual plug of the battery pack should be connected to the individual port of the charger.

If the voltage of any one or more cells varies abonrmal during the procedure,B610A terminates the process forcibly with the error message.If this happens,the battery pack contains the bad cell,or the bad connection of the cable or plug.You can easily know which one cell is bad by pressing INC> button at time of showing the error message.

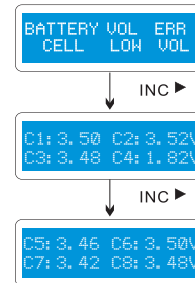

The peocessor found that the voltage of one of the cell in the Lithium battery pack is too low.

In this case, the 4th cell is bad.If there happens the connection-break of the cable or plug,the voltage value may show zero.

These programs are for charging or discharging NiMH (Nickel-Metal-Hydride) or NiCd (Nickel-Cadmium) battery commonly used for R/C model applications.To alter the value at the display,press **Start/Enter** key to make it blink then change the value using **INC>** or **<DEC** key. The value will be stored by pressing **Start/Enter** key once.

To start the process,press **Start/Enter** button for more than 3 seconds.

### Charging NiCd/NiMH battery

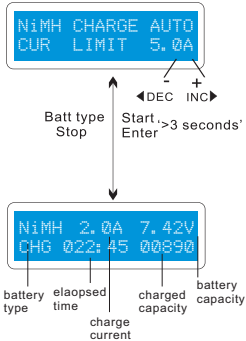

This program simply charges the battery using the current you set.In 'Aut' mode,you need to set the upper limit of charge current to avoid from higher feeding current that may damage the battery. Because some batteries of low impedance and small capacity can lead to the higher charge current by the processor at automatic charge mode.But in 'Man' mode,it will charge the battery with the charge current you set at the display. Each mode can be switched by pressing **INC>** and **<DEC** button simultaneously when the current field is blinking.

The screen displays the current state of charging. To stop the process press **Batt.Type/Stop** key once. The audible should indicates you the end of process.

### Discharging NiCd/NiMH battery

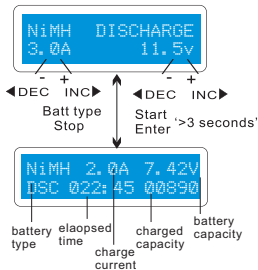

Set discharge current on the left and final voltage on the right.The discharge current ranges from 0.1 to 5.0A and the final voltage ranges from 0.1 to 25.0V.To start the process,press **Start/Enter** key for more than 3 seconds.

The screen displays the current state of discharge. You can alter the discharge current by pressing **Start/Enter** key during the process.Once you change the current value,store it by pressing **Start/Enter** button again. To stop discharging press **Batt.Type/Stop** key once.The audible sound indicates you at the end of process.

### Charge-to-discharge & discharge-to-charge cycle NiMH/HiCd battery

Set the sequence on the left and the number of cycle on the right.You can use this function for balancing,refreshing and break-in the battery,there will a brief cool-off period that already fixed at 'User setting' after each charge and discharge process.The cycling number ranges from 1 to 5.

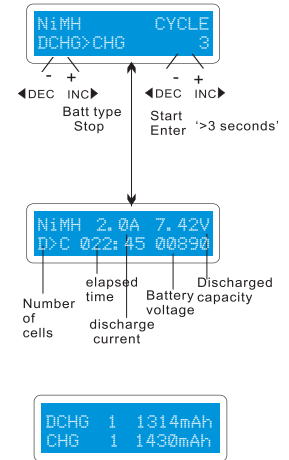

To stop the process,press **Batt.Type/Stop** key once. You can change the discharge or charge current by pressing **Start/Enter** key once during the process.The audible sound indicates you the end of process.

At the end of the process,you can see charged or discharged electric capacities of the battery of the battery at each cyclic process. By pressing **INC>** or **<DEC** button,the screen shows the result of each cycle in order.



This is programmed for charging pb(lead-acid)battery with nominal voltage from 2 to 24v.Pb batteries are totally different from NiCd or NiMH batteries.They can only deliver relatively lower current compare to their capacity,and similar restrictions definitely apply to charge.So the optimal charge current will be 1/10 of the capacity.Pb batteries must not be charged rapidly.Always follow the instruction is supplied by the manufacturer of battery.

When you are willing to alter the parameter value in the program,press **Start** key to make it blink then change the value with **INC** or **DEC** key.The value will be stored by pressing Strt key once.

### Charging pb battery

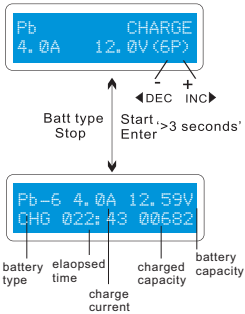

Set up the charge current on the left and the nominal voltage of the battery on the right.The charge current ranges from 0.1 to 10.0A and the voltage should be matched with the battery being charged.  
Start the charge process by pressing **Start** key for more than 3 seconds.

The screen displays the state of charging process.To stop charging forcibly,press **Batt type** key once.  
The audible sound indicates you at the end of process.

### Discharging pb battery

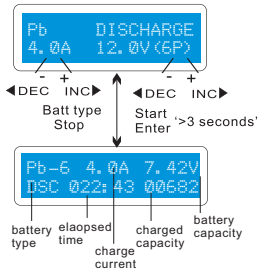

Set discharge current on the left and final voltage on the right.The discharge current ranges from 0.1 to 5.0A.  
To start the process,press **Start** key for more than 3 seconds.

The screen displays the current state of discharge.You can later the discharge current by pressing **Start** key during the process.Once you change the current value,store it by pressing **Start** button again.  
To stop discharging press **Batt type** key once.The audible sound indicates you at the end of process.

### Save Data program

B6 10 Pro has a data storage and load program for your convenience.This feature can store up to 10 battery data by number that represent the individual specification of batteries you are using.They can be called back for the process of charging or discharging without setting up the program again.To set up the parameter value in the rogram,press **Start/Enter** key to make it blink then change the value with **INC**> or < **DEC** key.

The parameter value setting up in this screen does not affect charge or discharge process.They only represent the specification of the battery.The following screens will automatically be displayed exactly matched with the battery type you set up.The example shows the battery pack of NiMH,12 cells and 3000mAh of capacity.

Set up the charge current for manual charge mode,or the current limit for automatic charge mode.Each mode can be switched by pressing **INC** > and < **DEC** button at the same time when the current field is blinking.

Setting up discharge current and final voltage.

Setting up the sequence of charge and discharge,and the cycling number.

Saving the data.

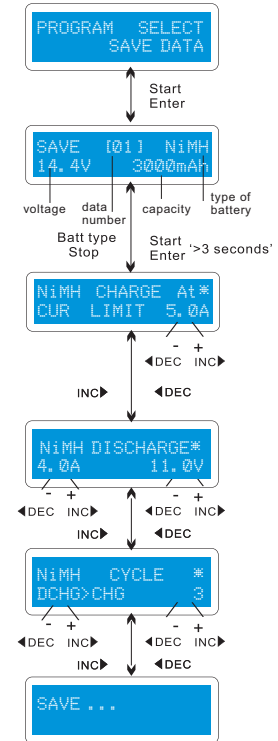

This program calls back the data that was stored at 'Save Data'program.

To load the data,press **Star/Enter** key once to blink the data number field and select the number using **INC>** or **<DEC** key then press **Star/Enter** key for more than 3 seconds.

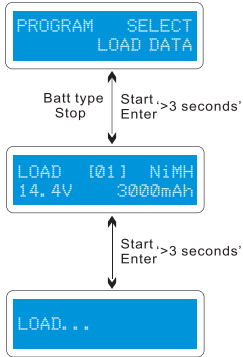

Select the data number to be called back.  
The data matched with the number will be displayed.

Loading the data.

### Various information during the process

You can inquire various information on LCD screen during charging or discharging process.when you press **<DEC** button the charger shows the establishment of user settings.And also you can monitor the voltage of individual cell by pressing **INC>** button when the individual connection cable is linked to the Lithium battery being processed.

The final voltage will be reached at the end of process.

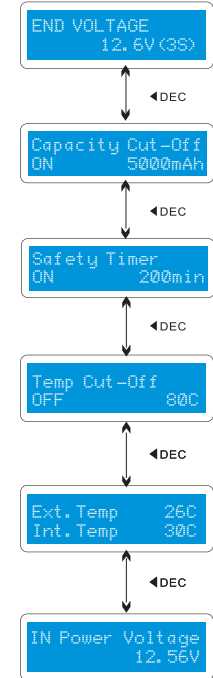

The internal temperature of the charger and the temperature of battery being charged.  
(The external temperature only will be displayed when the temperature probe is used.)

The present voltage of input DC power.

B6 10 Pro incorporates a various functions of protective and monitoring the system to verify functions and the state of its electronics. In any case of occurring error, the screen displays the cause of error that is self-explanatory with audible sound.

REVERSE POLARITY

The output is connected to a battery with incorrect polarity.

CONNECTION BREAK

This will be displayed in case of detecting an interruption of the connection between battery and output or voluntarily disconnecting the charge lead during the operation of charge or discharge on output.

SHORT ERR

There was a short-circuit at OUTPUT. Please check the charging leads.

INPUT VOL ERR

The voltage of input power drops below the limit.

VOL SELECT ERR

The voltage of Lithium battery pack was selected incorrectly. Verify the voltage of battery pack carefully.

BREAK DOWN

There happens the malfunction at the charger circuit by any reason. The charger should be repaired at the factory.

BATTERY CHECK  
LOW VOLTAGE

The peocessor detects the voltage is lower than you set at Lithium program. Please check the cell count of the battery pack.

BATTERY CHECK  
HIGH VOLTAGE

The peocessor detects the voltage is higher than you set at Lithium program. Please check the cell count of the battery pack.

BATTERY VOLTAGE  
CELL LOW VOL

The voltage of one of the cell in the Lithium battery pack is too low. Please check the voltage of the cell one by one.

BATTERY VOLTAGE  
CELL HIGH VOL

The voltage of one of the cell in the Lithium battery pack is too high. Please check the voltage of the cell one by one.

BATTERY VOL ERR  
CELL CONNECT

There are bad connection at the individual connector. Please check the connector and cables carefully.

TEMP OVER ERR

The internal temperature of the unit goes too high. Cool down the unit.

CONTROL FAILURE

The processor can not continue to control the feeding current by any reason. The unit needs to be repaired.

## Glossary of terms

**Amps(A):** The unit of measure for charge or discharge electric current. The program of the charger will show most of the current in amps(A) at its LCD screen.

**Milli-amps(mA):** The electric current, being amps(A) multiplied by 1000 and noted as 'mA'. So 2.0A is the same as 2000mA ( $2.0 \times 1000$ ). Or, to convert mA to amps, divide the mA number by 1000. So 200mA is the same as 0.2A. If a current value is below 1.0A, the LCD screen of the charge will still show the current in amps, not milli-amps. For example, a current of 600mA will be displayed as 0.6A, and a current of 100mA will actually be shown as 0.1A.

**Capacity, milli-amp hours (mAh), and amp-hours(Ah):** Charge energy stored by a battery is called capacity, which is defined as how much current a battery can supply constantly over one hour of time. Most hobby batteries are rated for capacity in 'mAh' or milliamp hours. A 650mAh battery can deliver 650mAh of current for one hour ( $650\text{mA} \times 1\text{hr} = 650\text{mAh}$ ). The batteries of very large capacity, such as lead-acid (Pb) batteries, are usually rated in 'Ah' or amp-hours. A 12V 60Ah car battery can deliver 60 amps of current for one hour ( $60\text{A} \times 1\text{hr} = 60\text{Ah}$ ).

**Nominal voltage(V):** The nominal voltage of the battery pack can be determined as follows;

- Nidc or NiMH: multiply the total number of cells in the pack by 1.2. A 8-cell pack will have a nominal voltage of 9.6 volts ( $8 \times 1.2$ ).
- LiPo: multiply the total number of cells in the pack by 3.7. A 3-cell LiPo wired in series will have a nominal voltage of 11.1 volts ( $3 \times 3.7$ ).
- Lilo: multiply the total number of cells in the pack by 3.6. A 2-cell Lilo wired in series will have a nominal voltage of 7.2 volts ( $2 \times 3.6$ ).
- LiFe: multiply the total number of cells in the pack by 3.6. A 2-cell Lilo wired in series will have a nominal voltage of 13.2 volts ( $4 \times 3.3$ ).

If the nominal voltage of the battery is not printed on the battery's label, consult your battery manufacturer or supplier. Do not guess the rated voltage of battery.

**'C'-rating:** Capacity is also referred to as the 'C'-rating. Some battery suppliers recommend charge and discharge currents based on the battery 'C' rating. A battery '1C' current is the same number as the battery's rated capacity number, but noted in mA or amps. A 600mAh battery has a 1C current value of 600mA, and a 3C current value of ( $3 \times 600\text{mA}$ ) 1800mA or 1.8A. The 1C current value for a 3200mAh battery would be 3200mA (3.2A).

## Balancing the multi Lithium battery packs

You can charge and balance several Lithium batteries at the same time, by using optional 'Multi-board adaptor'(\*). Please note that the battery packs being charged should have same capacity and cell-count.

\*Please read the instructions comes with the board for the maximum safety.

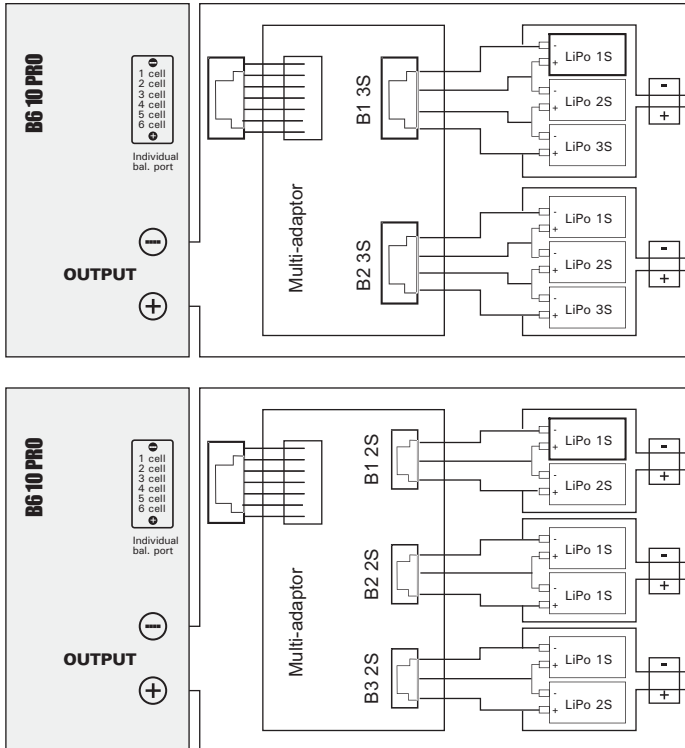

## Maximum circuit power chart

For the voltage of battery is more than 20V, the actual amount of charge current delivered to the battery might automatically be limited, so not to exceed the charge's maximum rated charging power of 200 watts. And also, for the battery having more than 5V, the discharge current delivered to the battery might be limited by the maximum rated discharge power of 25 watts. The actual feeding current will be as follows:

Maximum charge/discharge current at 12V DC input				
	No. of cells	Nominal voltage(V)	Charge current(A)	Discharge current(A)
NiCd/ NiMH	1	1.2	10.0	5.0
	2	2.4	10.0	5.0
	3	3.6	10.0	5.0
	4	4.8	10.0	5.0
	5	6.0	10.0	4.1
	6	7.2	10.0	3.4
	7	8.4	10.0	2.9
	8	9.6	10.0	2.6
	9	10.8	10.0	2.3
	10	12.0	10.0	2.0
	11	13.2	10.0	1.8
	12	14.4	10.0	1.7
	13	15.6	10.0	1.6
	14	16.8	10.0	1.4
	15	18.0	10.0	1.3
	16	19.2	10.0	1.3
	17	20.4	9.8	1.2
	18	21.6	9.2	1.1
LiPo	1S	3.7	10.0	5.0
	2S	7.4	10.0	3.3
	3S	11.1	10.0	2.2
	4S	14.8	10.0	1.6
	5S	18.5	10.0	1.3
	6S	22.2	9.0	1.1
LiFe	1S	3.3	10.0	5.0
	2S	6.6	10.0	3.7
	3S	9.9	10.0	2.5
	4S	13.2	10.0	1.9
	5S	16.5	10.0	1.5
	6S	19.8	10.0	1.2
Pb	6.0	10.0	4.1	
	12.0	10.0	2.0	
	24.0	8.3	1.0	

## Specifications

Operating voltage range:	10.0-18.0 Volt
Circuit power:	max.200Watts(charging) max.25Watts(discharging)
Charge current range:	0.1-10.0A
Discharge current range:	0.1-5.0A
Current drain for balancing Lipo:	200mAh/cell
NiCd/NiMH battery cell count:	1-18 cells
Lithium battery cell count:	1-6 Series
Pb battery voltage:	2 to 24V
Weight:	480 g
Dimensions:	143×119×42 mm



## Warranty and service

We warrant this product for a period of one year (12 months) from the date of purchase. The guarantee applies only to such material or operational defects, which are present at time of purchasing the product. During the period, we will repair or replace without service charge any product deemed defective due to those cause. You will be required to present proof of purchase (invoice or receipt). This warranty does not cover the damage due to wear, overloading, incompetent handling or using of incorrect accessories.



Electrical equipment marked with the cancelled waste bin symbol must not be discarded in the standard household waste; instead it should be taken to a suitable specialist disposal system.